

# Tile Tech Pavers<sup>®</sup>

*Paving America one step at a time.*

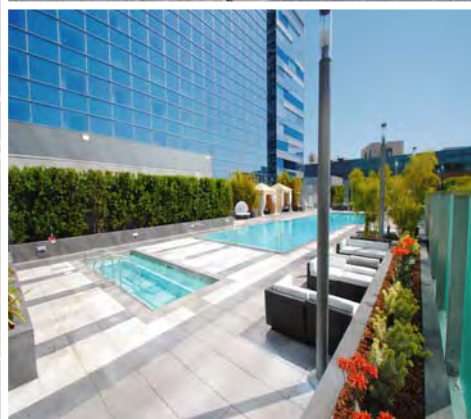

MANUFACTURER OF PAVERS & ADJUSTABLE PEDESTAL SYSTEMS

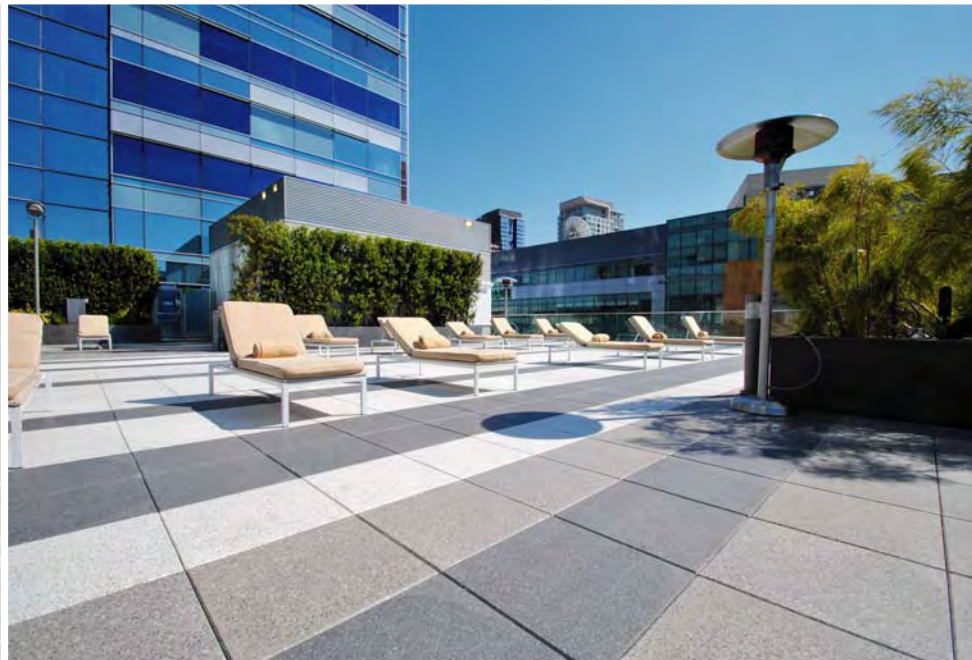

## Applications

Roof Decks  
Plaza Decks  
Pool Decks

..... 3

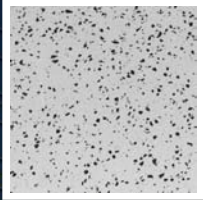

## Roof & Plaza Pavers

Granite-Tech™ Series

..... 6

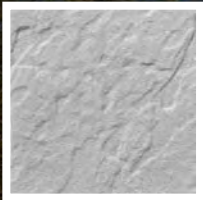

## Roof & Plaza Pavers

Stamp-Tech™ Series

..... 8

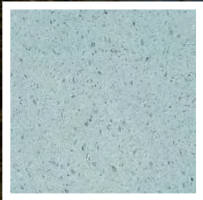

## Roof & Plaza Pavers

Cool-Roof™ Series

..... 10



## Adjustable Pedestals

HYBRID Pedestal™ System  
- Uni-Just™  
- Stack-Cap™

..... 12



## Installation Details

Pavers over Pedestal

..... 14



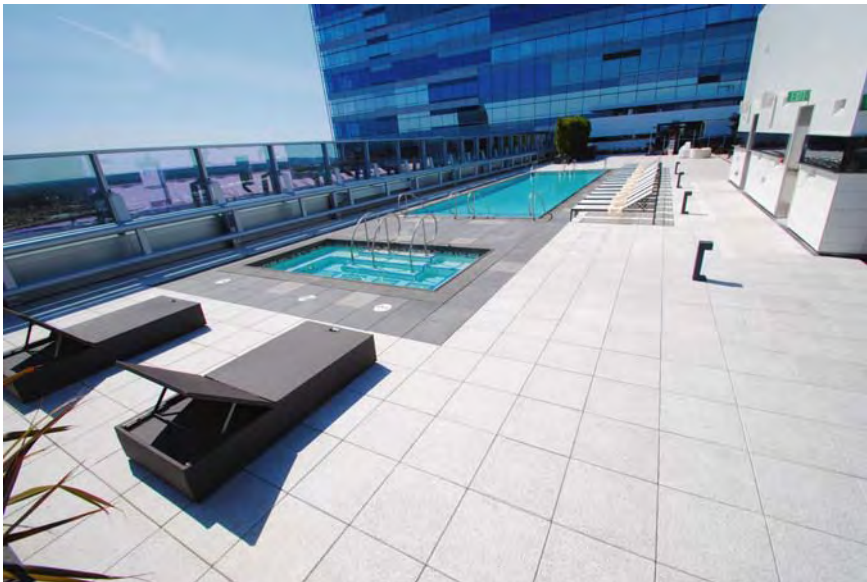
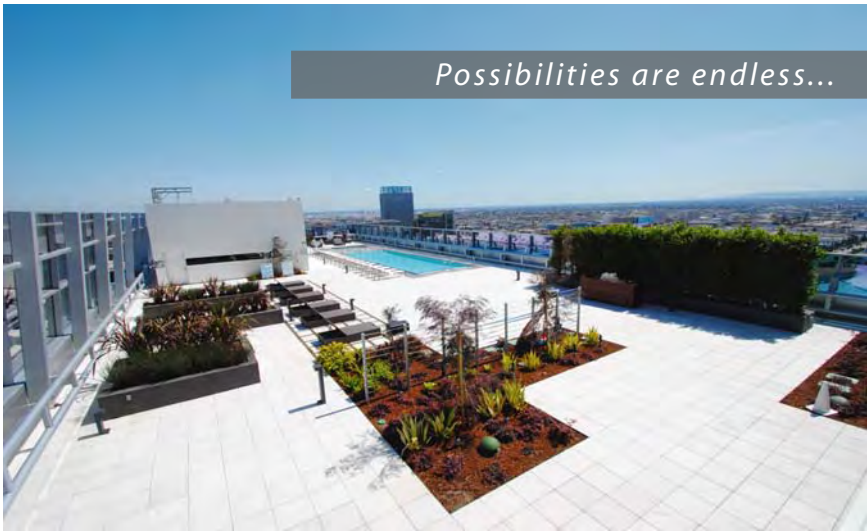

Above, Left, Right & Lower Right: Ritz Carlton / JW Marriott - LA Live Architect: Gensler  
 Application: Roof Deck - Pedestal Set Size & Color: 20" x 20" Charcoal, Gray Black & White Black

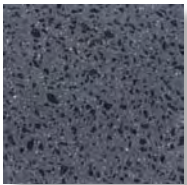

Charcoal

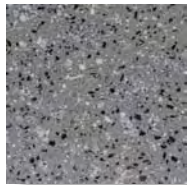

Gray Black

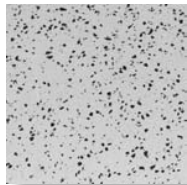

White Black



Tile Tech Pavers are available in both a standard color range and custom aggregate blends (see full catalog). Striping, banding and paving patterns are just a few of the design capabilities made possible by mixing various paver colors, sizes and finishes. Whether your project is a roof, deck, plaza or terrace, **Tile Tech Roof Pavers are attractive, functional and serviceable!**

The concept of using concrete pavers as roof ballasts, plaza decks and terraces has created new opportunities for otherwise lost spaces. Roofs and decks can now be functional, as well as attractive. Tile Tech Pavers provide durability, protection and performance for the roof system from harsh weather conditions while providing **drainage** and a **level** walking surface.

Tile Tech Pavers offers a solution for all roofing & waterproofing needs from standard Walkway and Roof Ballast, to Architectural Plazas and Green Roofs. Functional design, color and durability all come together with Tile Tech roof and plaza pavers.

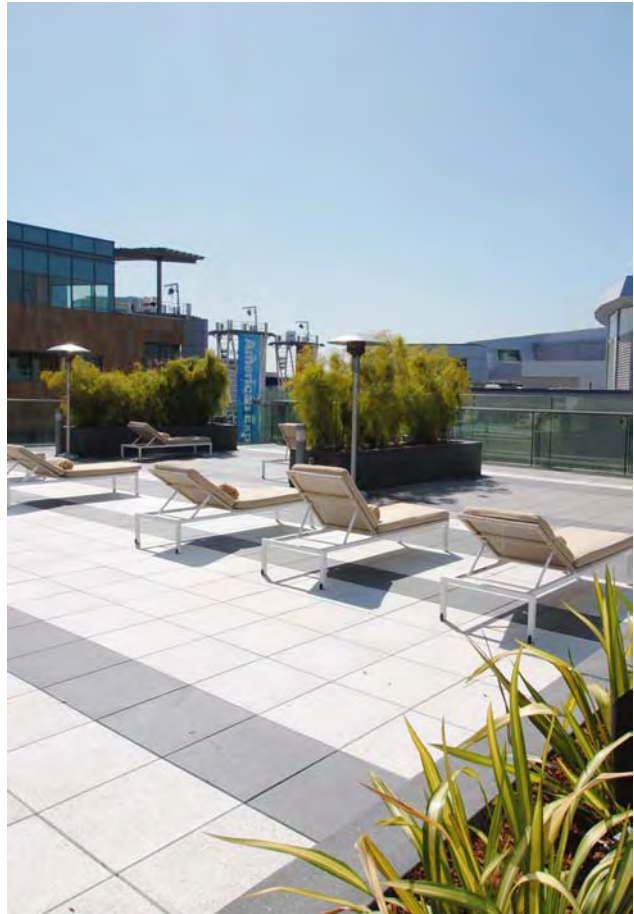

# 4 Pedestal System - Application

The application of an elevated paver system provides the designer with new possibilities and advantages. Tile Tech Pedestal Paver System elevates, levels and uniformly spaces pavers thus allowing water to be channeled away from the surface. Roof and Plaza Pavers allow easy access to the roof and waterproofing system for making repairs or standard maintenance procedures.

The popularity of energy-efficient Green Roofs is increasing as its value is appreciated. Tile Tech Pavers has developed a series of cool pavers that provide reflectance and emittance values providing great performance to the Green Roof concept thus keeping the building cooler and more energy efficient.

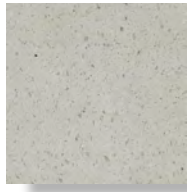

Penny Lane:  
Reflectance = 73%  
Emittance = .95  
SRI = 91

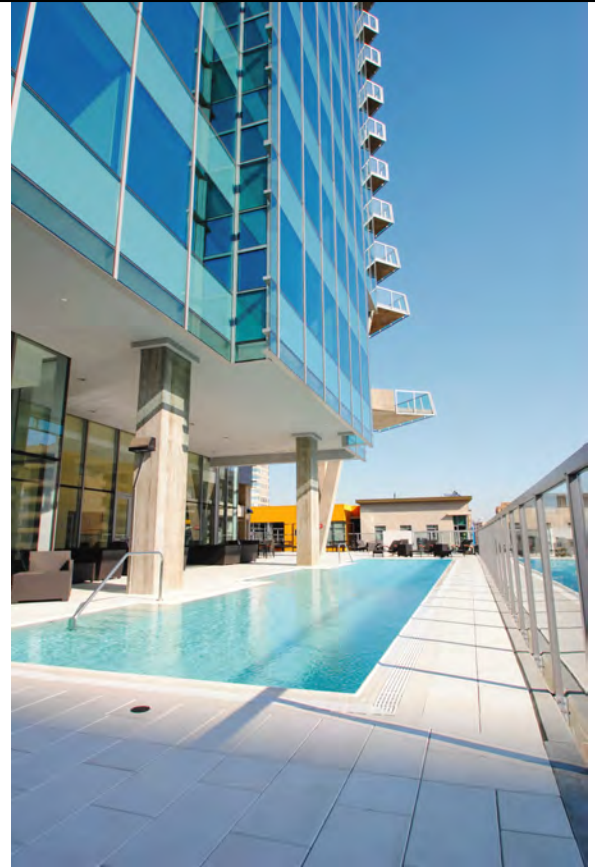

Above & Top Right: Watermarke Tower - Los Angeles, Ca  
Architect: ArchEON Group

Application: Roof Deck - Pedestal Set  
Size & Color: 12" x 24" x 1-1/2" Penny Lane



Pat. # 8,453,391 & Pat. Pen



Hydro Brown



Pedestal System



Above & Right: Optima Biltmore Towers, Phoenix - AZ  
Architect: Davis Hovey & Associates  
Application: Roof Deck - Pedestal Set; Size & Color: 20" x 20" Hydro Brown





The conventional method of setting precast concrete, stone or other type paving slabs into a sand, gravel or mortar bed has had a deleterious effect on many types of promenade and other deck systems. The entry of surface water into these systems causes pavers to heave due to freeze-thaw cycling, wash-out, break-up, and eventually cause deterioration of the water-proofing membrane over occupied areas below. The high cost of replacement, leveling and aligning the pavers as well as repairs to the water-proofing, is an ongoing maintenance problem.

***Tile Tech pedestal system elevates, levels, provides substrate protection and uniformly spaces*** pavers for proper water drainage in such waterproofed installations as roof decks and promenades, terraces, balconies, patios, podiums, plazas, arenas and roof gardens. It is also ideal for roof garden walkways, for use as support pedestals or sleepers for catwalks, mechanical access walkways, balcony-deck structures and roof-mounted duct pipes. They also allow easy access to the roof and waterproofing system for making repairs or standard maintenance procedures a breeze!

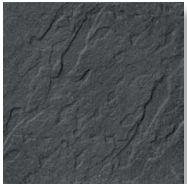

Slate - Black



Slate - Tan



Slate - Natural



Above & Top Left : Solairs - Los Angeles, CA  
Architect: ArchEON Group

Application: Roof Deck - Pedestal Set  
Size & Color: 20" x 20" x 2" Stamp-Tech: Slate Black, Natural & Tan



Above & Right : Wit Hotel - Chicago, IL  
Architect: Koo & Associates  
Application: Roof Deck - Pedestal Set  
Size & Color: 16" x 16" Stamp-Tech: Slate Black



**Granite-Tech™** roof pavers are produced under extreme hydraulic pressure by bonding crushed granite & limestone together within a color cement matrix duplicating the forces of nature. The pavers are then ground to expose the beauty of the natural granite chips and can be honed or shot blasted resulting in a granite-like, slip resistant & high strength paver.

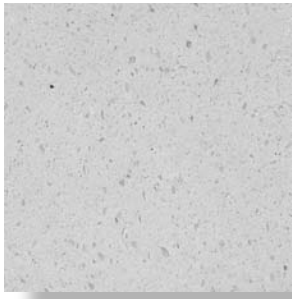

Penny Lane

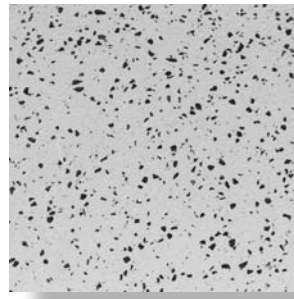

White Black

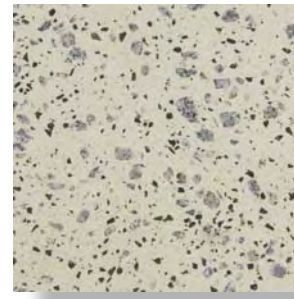

Vanilla Gray

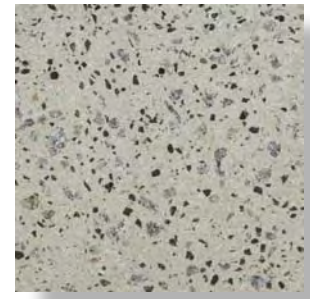

Straw

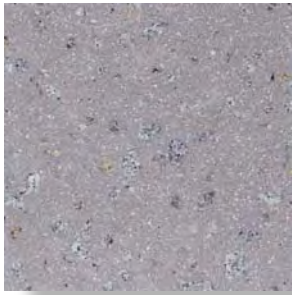

Pewter

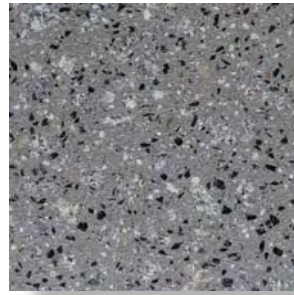

Gray Black

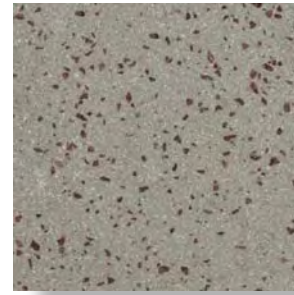

Mist Wine

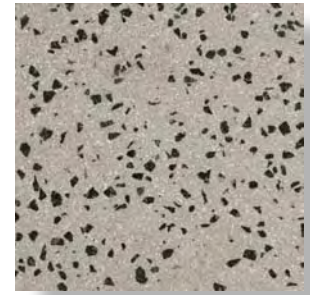

Mist Black Large

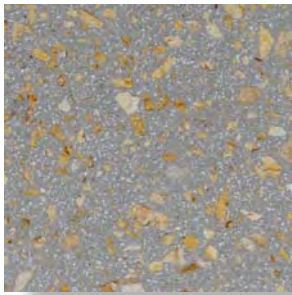

Mist Gold

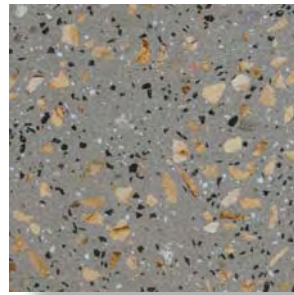

Gray Brown

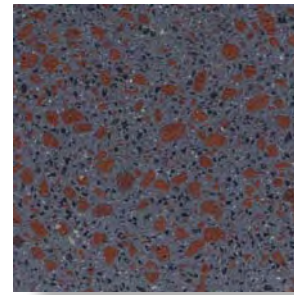

Charcoal Brick

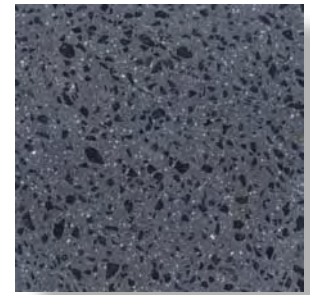

Charcoal

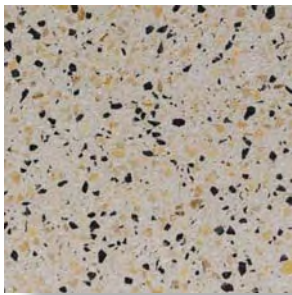

Cream Black



Cream White

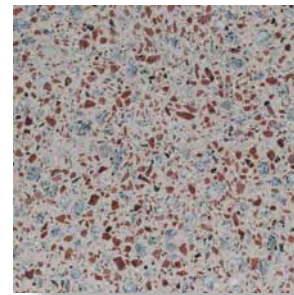

Rose Wine

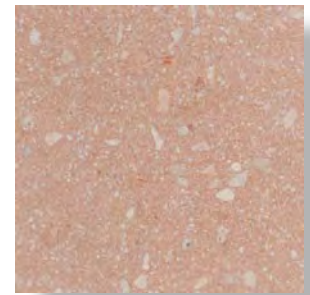

Peach

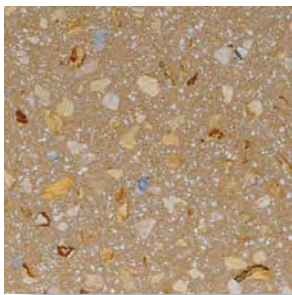

Mocha Gold



Brown Gold

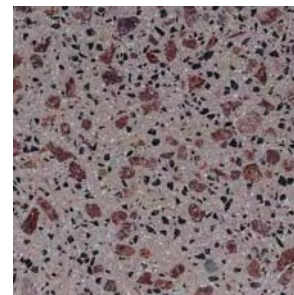

Brown Wine

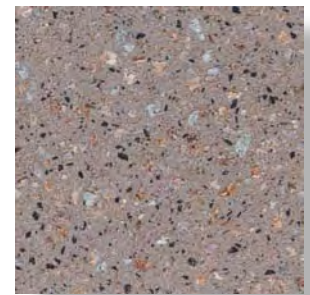

Hydro Brown

**Please Note:** Colors & finishes shown are only a representation. Please request samples for approval.

Designed to mimic the natural beauty of granite, **Granite-Tech™** pavers gives the surface a granite-like appearance which adds slip resistant qualities to the paver. Matching stair treads and pool copings are also available.

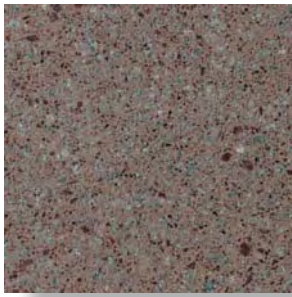

Rose Brown

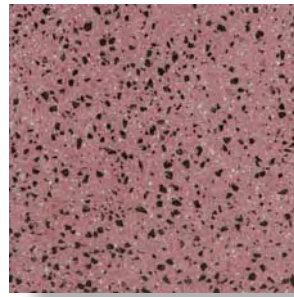

Red Black

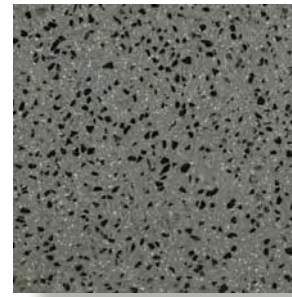

Green Black

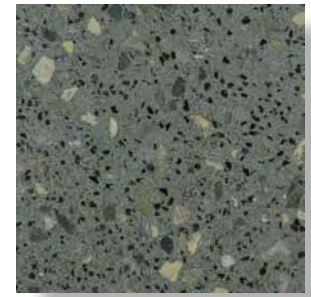

Verde Green

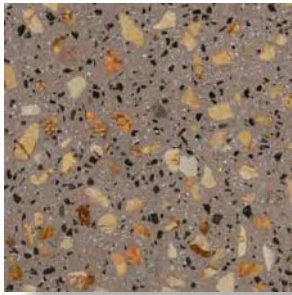

Brown Peach

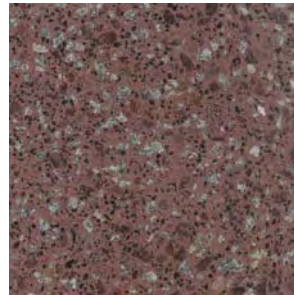

Burgundy Wine

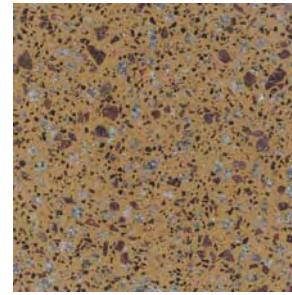

Mustard Wine



Gray Peach

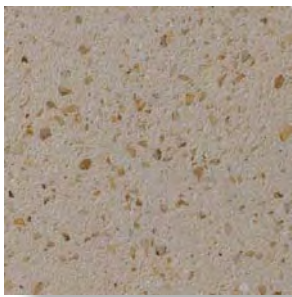

Desert Large Gold



Desert Small Gold

## Custom Colors & Designs

**Granite-Tech™** Pavers are available in an unlimited choice of colors & mix designs. There are also several finishes to choose from. The surface can be shot blasted or polished and can be sealed or unsealed. Our design team will formulate custom mix designs to meet any design requirements.

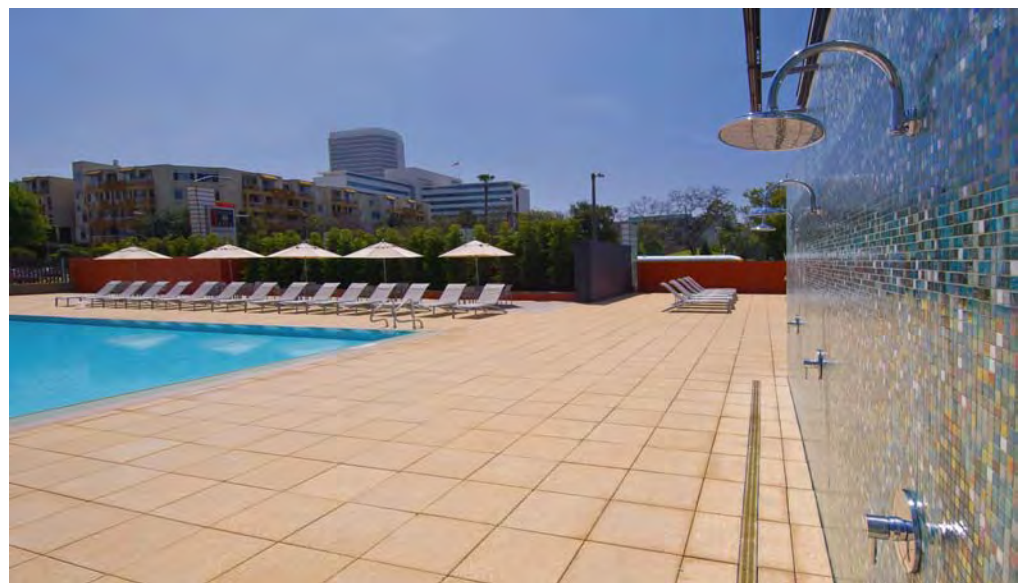

Above & Left : Park La Brea Apartments - Los Angeles, CA  
Architect: Caudet Design Group

Application: Pool Deck - Pedestal Set  
Size & Color: 20" x 20" x 2" Granite-Tech: Mocha Gold

**Stamp-Tech™ Slate** pavers have been designed to reproduce the texture, color and appearance of natural slate. Its irregular top surface was developed from actual sections of stone. By rotating the direction of the pavers during installation the natural effect is complete. Slate face pavers are available in several size from a nominal 12" x 12" to a nominal 20" x 20" in addition to various colors seen bellow.

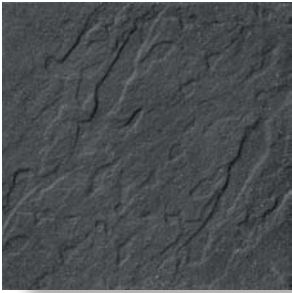

Slate - Black



Slate - Natural



Slate - Tan



Slate - Desert



Fox Red



Paver Red



Prairie Tan



Sandalwood



Orchid



Buckskin



Redwood



Burlap

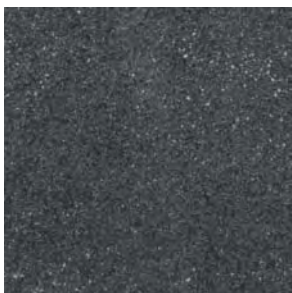

Flat - Black



Flat - Smoke



Flat - Concrete Base



Slate - Verde

Laying Options

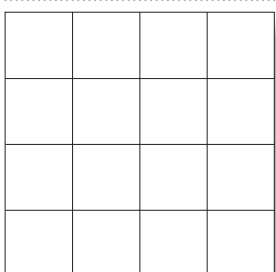

Stackbond

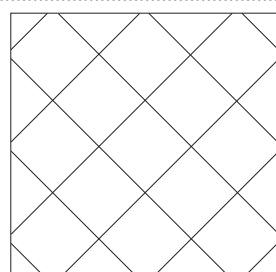

Diamond

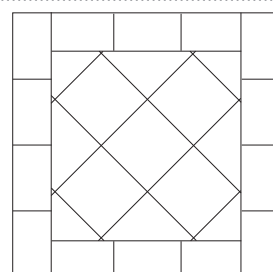

Diamond w/ border

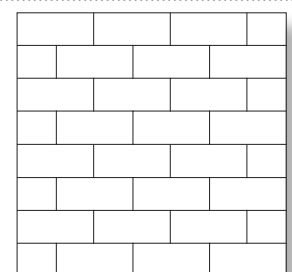

Running Bond



**Stamp-Tech™** pavers can be manufactured in wide range of sizes and designs in addition to endless color & aggregate mixes. Any of our standard size options or custom sizes (order size permitting) can be manufactured in most of the designs seen bellow. Our wide design options range from a flat monochromatic finish, Stamped Slate finish to a more architectural finish such as the Granite-Tech™ series.



FLAT Design



SLATE Design



FOSSIL Design



CORAL Design



WAVE Design



FAN MACRO Design



FAN MICRO Design



ROMA Design



DIAMOND Design



PLANK Design



BASKET WEAVE Design

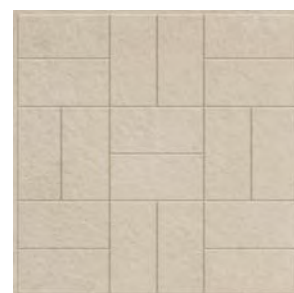

BRICK Design

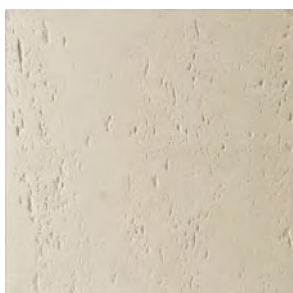

TRAVERTINE Design

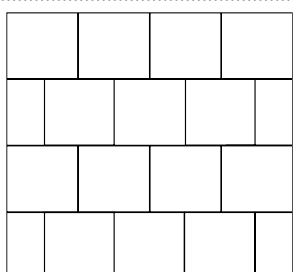

Laying Options

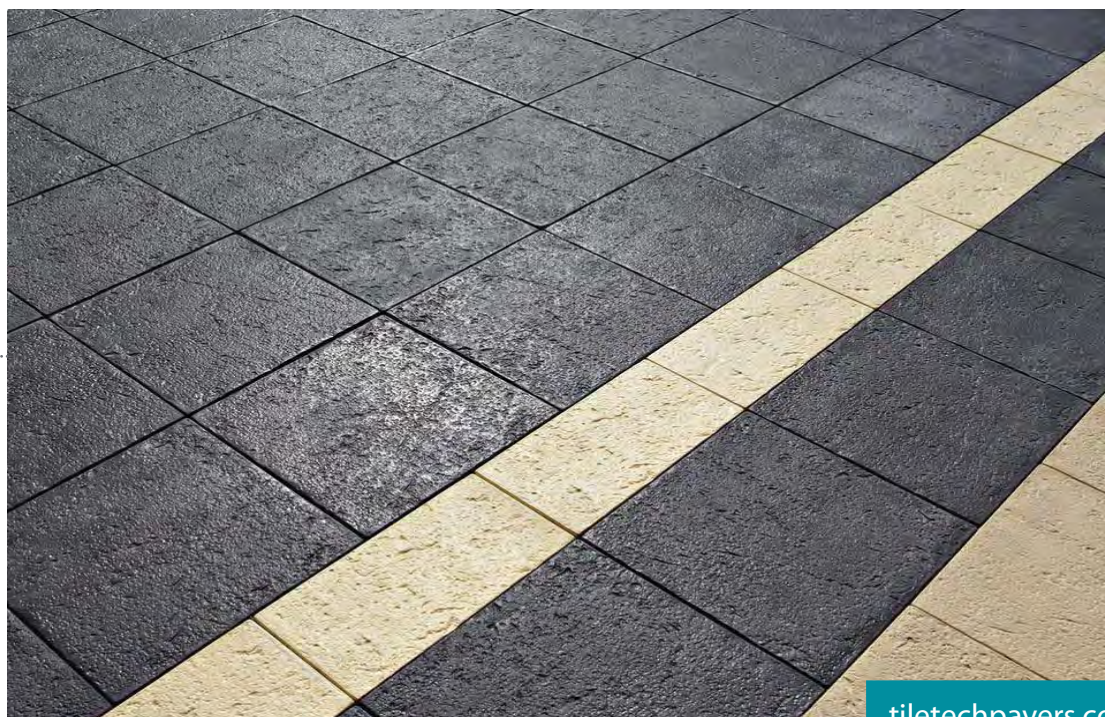

**Cool-Roof™** paver can become an integral part of achieving LEED value credits under LEED NC Version 2.1 Credit 7.2. Full one credit value under Heat Island Effect Roof for compliance with ASTM E 408 in conjunction with this LEEDS version can be achieved by specifically utilizing the Penny Lane or Cool-White color with a value of .9 or greater. Our Cool-Roof™ pavers can be used for plaza or roof applications requiring LEED certification in either pedestal configurations and/or loose-laid applications.

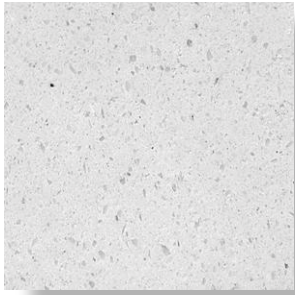

Cool-White



Cool-Blue



Cool-Green



Cool-Yellow

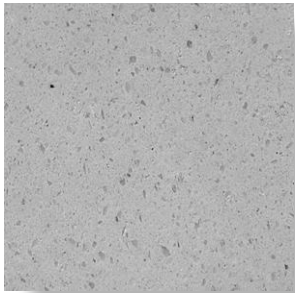

Cool-Gray



Cool-Red



Cool-Orange



*Energy efficiency at your feet...*

PAVER SPECS	Size L x W (inch)	Thickness (inch)		Weight per SqFt (Lb)	Weight per Unit (Lb)	Unit per Pallet (pcs)	Colors			
		1"	1-1/2"				2"	Granite-Tech	Stamp-Tech	Cool-Roof
 12 x 12	11.875" x 11.875" 300mm x 300mm	1"	•	11lb	11lb	250	•	•	•	
		1-1/2"	•	21lb	21lb	126				
 12 x 24	11.875" x 23.622" 300mm x 600mm	1"	•	16lb	32lb	95	•	•	•	
		1-1/2"	•	20lb	40lb					
 16 x 16	15.75" x 15.75" 400mm x 400mm	1"	•	15lb	30lb	108	•	•	•	
		1-1/4"	•							
 16 x 24	15.75" x 23.622" 400mm x 600mm	1"	•	16lb	42lb		•	•	•	
		1-1/4"	•	21lb	55lb					
 20 x 20	19.68" x 19.68" 500mm x 500mm	1"	•	21lb	58lb	48	•	•	•	•
		1-1/2"	•							
 Coping	48" x 14" 1200mm x 400mm *Full Rounded Bullnose	1"	•	18lb	70lb	12	•	•	•	

PAVER PROPERTIES	TEST METHOD	RESULTS
Compressive Strength	ASTM C-140	8,000psi Min
Flexural Strength	ASTM C-293	700psi Min
Water Absorption	ASTM C-936	5% Max
Coefficient of Friction	ASTM C-1028	0.6% Min
Freeze Thaw	ASTM C-67	1% Max
Dimensional Tolerance	+/- 1/16" Length, width, height, convex, concave.	

### MAINTENANCE

Pavers will require some periodic maintenance to keep them in a reasonable condition. Dirt, dust and leaves should be regularly removed and any weed growth should be sprayed and controlled.

### CLEANING

All pavers will require cleaning from time to time. Oil, rust, efflorescence and other stains can detract from the appearance of the paver. Specialized cleaning products for concrete pavers are readily available.

### SEALING

If a more protective surface is required or the pavers will knowingly be subject to salt attack then we suggest sealing your paving. Tile Tech recommends sealing pavers not for structural reasons but for aesthetic and maintenance purposes.

For complete material & installation specifications, please visit our website or contact us.

# H Y B R I D

Adjustable Pedestal System

**New**

**PATENT**  
filed for  
international  
patent  
**PENDING**



Pat. # 8,453,391 & Pat. Pen

**The Tile Tech Pedestal System is designed for concrete pavers to lay level over a built up roof.** The substrate can be either concrete or wood structure, with a roof membrane over the top.

Our new Hybrid Pedestal™ System consists of 7 standard components and off-the-shelf, 4.215" diameter SDR-35 PVC pipe. The PVC pipe allows the pedestal system to vary in height up to 22+ inches and is cut to the desired height using 12" chop saw. The Uni-Base is then "press fit" on to one end of the PVC pipe and a Uni-Collar on to the other end and requires no gluing or other attachments. Either 3/4" or 1-1/2" Uni-Insert is then screwed in to the Uni-Collar allowing for fine height adjustments. The assembly is completed by aligning and locking the Uni-Cap with the Uni-Insert. The Uni-Cap features include built-in self-leveling and removable 1/8" spacer tabs for proper paver spacing and joint alignment.



**Stackable caps** allow for minor height adjustments from 1/2" up to 6" and can compensate for slopes of 0% to 3% by aligning the built-in slope compensator of one cap relative to another. *Simple, easy and affordable!*



**Single model design** allows for all height applications from low as 1/2" and as high as 22" resulting in reduced labor and material cost. *Eliminates leftover parts and pieces!*







**PVC pipe adjustment** allows the pedestal system to vary in heights up to 22+ inches by using off-the-shelf 4"Ø SDR-35 PVC pipe available everywhere. *Eliminates material & shipping cost!*



**Screw adjustment** allows for quick and easy fine height tuning for an additional 3/4" or 1-1/2" depending on model size of UNI-INSERT™ used. *Eliminates having to cut pipe exactly!*

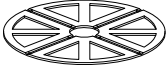
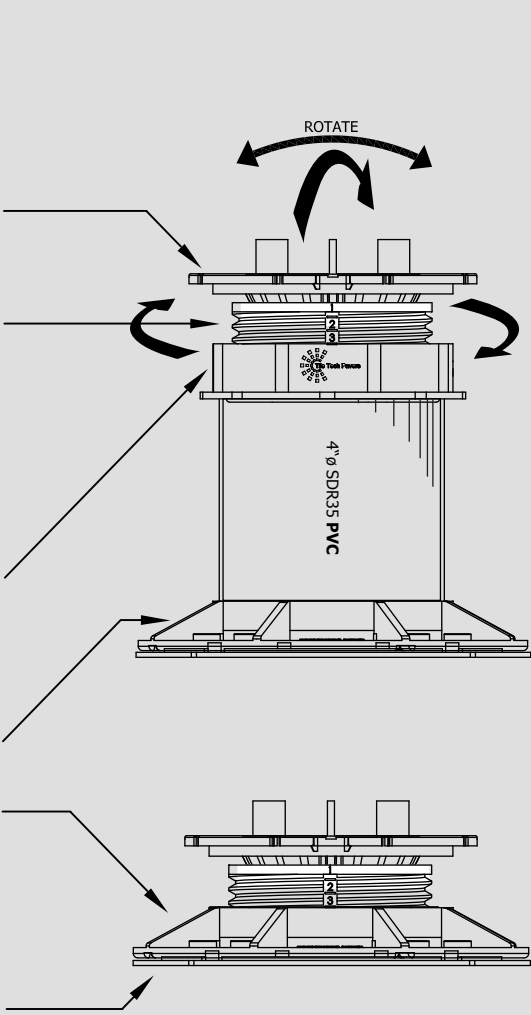

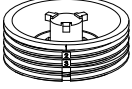
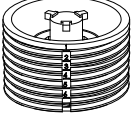
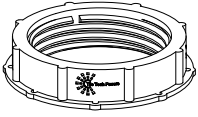
**Self-Leveling** head allows for slope compensation of 0% to 6% in any direction. Allen or Hex key will allow for leveling while loaded with pavers. *Eliminates having to remove pavers to make adjustments!*

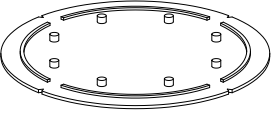
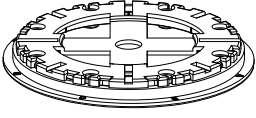
PEDESTAL DETAILS	Component	Function	Assembly Diagram
	<b>UNI-SHIM™</b> 1/8" & 1/16"	Allow for fine tuning of individual pavers. Can be broken in to quarters or halves and stacked on top or bottom of pedestals.	 <p>4"Ø SDR35 PVC</p> <p>UNI-Insert</p> <p>ROTATE</p>
	<b>UNI-CAP™</b>	Align and lock on to UNI-INSERT and allows for self-leveling in any direction from 0% to 6% slope.	
	<b>UNI-INSERT™</b> 3/4"	Screw in to UNI-COLLAR and allows for additional height adjustment of either 3/4".	
	<b>UNI-INSERT™</b> 1-1/2"	Screw in to UNI-COLLAR and allows for additional height adjustment of 1-1/2".	
	<b>UNI-COLLAR™</b>	Compression fits on to end of 4"Ø SDR-35 PVC pipe and allowing UNI-INSERT to screw in to the system.	
	<b>UNI-BASE™</b>	Compression fits on to end of 4"Ø SDR35 PVC pipe or can be used with UNI-INSERT alone.	
	<b>BUFFER PAD™</b> (Mandatory)	Used under base to provide slip resistance, noise dampening & membrane protection.	
	<b>STACK-CAPS™</b>	Used of low height requirements. Rotate and stack caps for slope & height adjustment. Can also be used with PVC pipe to reach 6" max.	

PEDESTAL PROPERTIES	TEST METHOD	RESULTS
Tensile Strength	ASTM C-638	6,300psi Minimum
Flexural Modulus	ASTM C-790	35,000psi Minimum
Flexural Strength	ASTM C-790	10,500psi Minimum
Softening Point	ASTM C-1525	226° F
Freeze Thaw	ASTM C-	Unaffected
Material	HDPP - High Density Polypropylene * Resistant to oils, acids, alkalis, bitumen, mold and algae.	



For complete material & installation specifications, please visit our website or contact us.



1. In a typical installation do not start first row of pavers at perimeter wall, instead begin installation of full pavers at the second row in the roof field.
2. Mark perpendicular guidelines on substrate surface to ensure square layout.
3. The first height of the pedestal is then determined and PVC pipe is cut with a standard 12" shop saw to the required height, less 3/8" for bottom base and collar insets plus buffer pad. The Uni-Insert will provide an additional 3/4" or 1-1/2" of height depending on the model size used.
4. Install initial pavers along guidelines forming a "T" pattern. Install remaining field pavers out from "T".
5. Perimeter pavers are installed last and normally cut and less than full size to ensure proper layout and fit. Pedestal spacer tabs can be removed in order to position pedestals at perimeter just tangent to wall.
6. Any section of the roof that receives concrete pavers that is not restrained by an abutting wall or parapet must be "boxed in" by some field installed restraint. No movement should be allowed at the perimeter of a paver system.

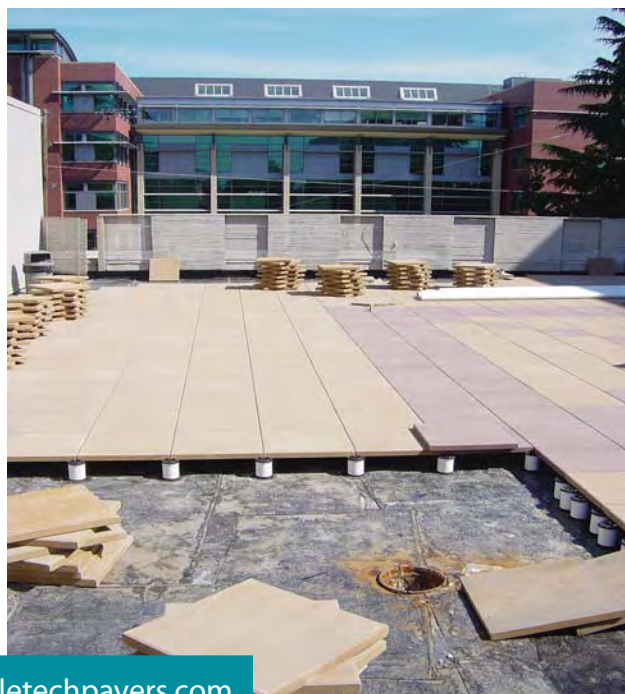
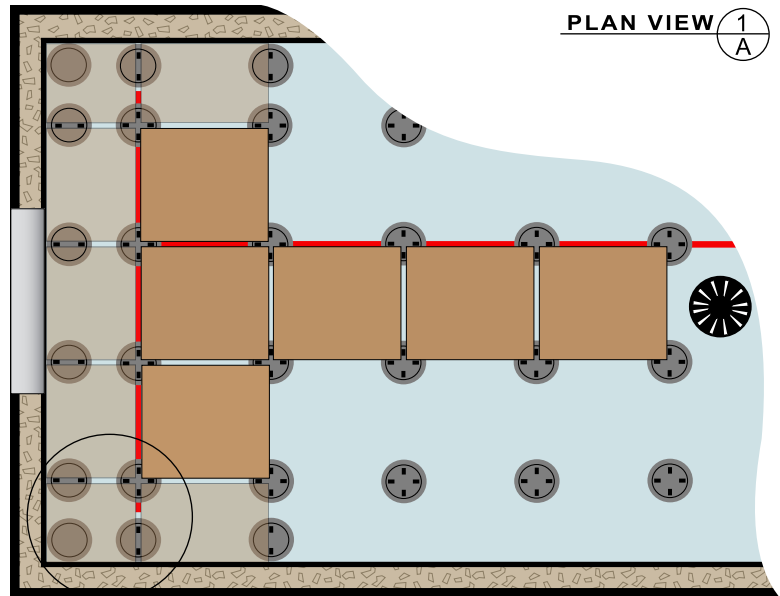

*A step above the rest...*

**Quick water drainage.** The gap between and under pavers allows for rapid water discharge on to substrate surface.

**Concealment of utilities, pipes and drains.** The void between the paving and membrane can be used to accommodate pipes and services including drains, but retain easy access for maintenance and repair.

**Thermal insulation & protection.** The void between the paving and membrane encourages constant air circulation, extending the life of the waterproofing and improving heat insulation in addition to protecting the substrate surface from UV degradation.

**Level paving & significant less weight.** With no requirement for special surface preparations, such as sand or aggregate bedding the floating system provides a level, light weight solution, allowing structures to be built with less loading on structure and at substantially lower cost.

## Single Ply Sheet Membrane

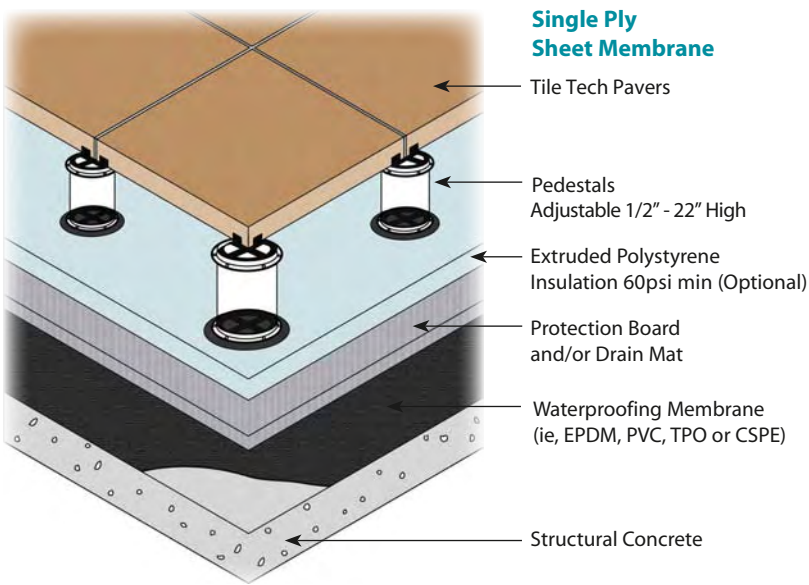

## Hot Rubber

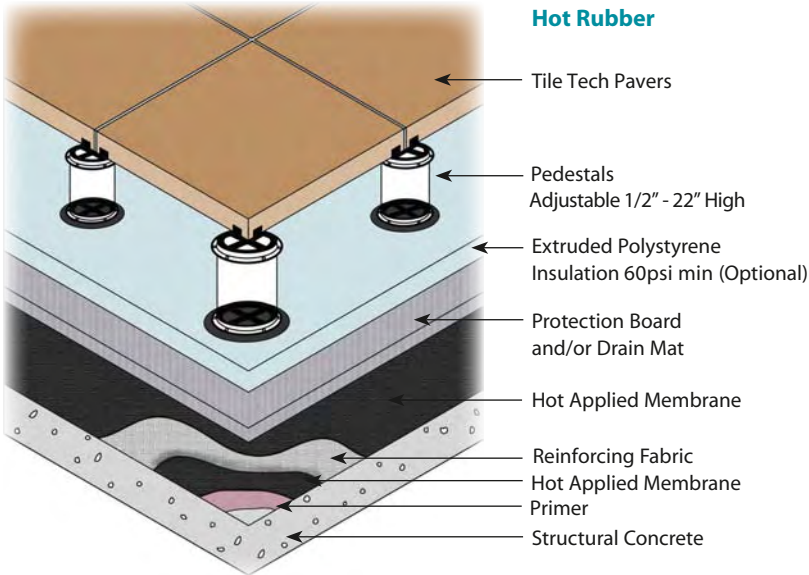

## Modified Bitumen

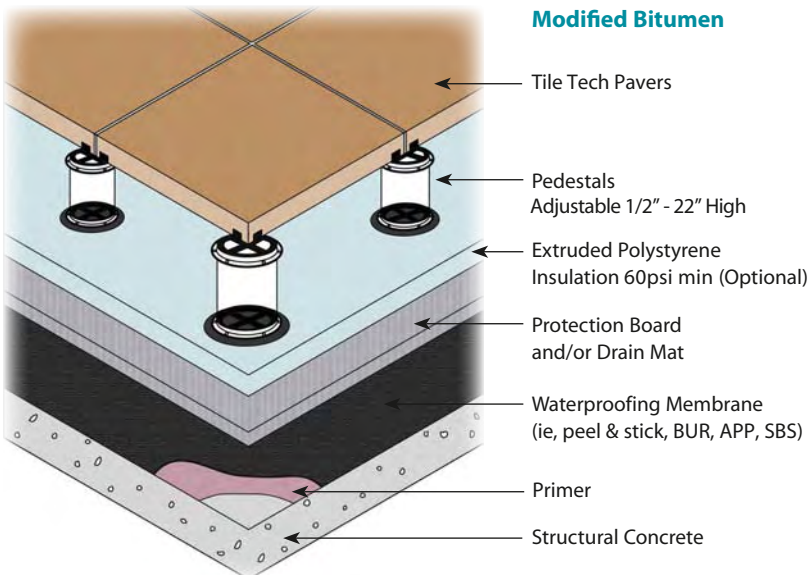

### PART ONE- GENERAL

#### 1.2 SUMMARY

- A. Scope of work
  - 1. Roof & Plaza Pavers
  - 2. Adjustable Pedestals

#### 1.4 SUBMITTALS

- A. Product Data Sheet
  - 1. Including preparation instructions, installation methods, storage and handling requirements.
- B. Samples
  - 1. Submit two sets of standard color chips of manufacturer's full range.

#### 1.5 QUALITY ASSURANCE

- A. Manufacturer
  - 1. Minimum of 5 years experience manufacturing precast pavers.
  - 2. Supply a written installation procedure manual.
- B. Installation Contractor
  - 1. Minimum of 1 year experience installing precast pavers on projects of similar size.
  - 2. Installation contractor must meet all local & state licensing & bonding requirements.

#### 1.8 WARRANTY

- A. Manufacturer
  - 1. Shall warrant installed pavers for a period of 5 year from date of substantial completion against failure of materials.
- B. Installation Contractor
  - 1. Shall warrant installed pavers for a period of 3 year from date of substantial completion against failure of workmanship.

### PART TWO - PRODUCTS

#### 2.1 MANUFACTURER

- A. Tile Tech Pavers Inc.
  - Tel.....213-380-5560
  - Fax.....213-380-5561
  - Toll Free.....888-380-5575
  - Web.....tiletechpavers.com

#### 2.2 MATERIALS

- A. Roof & Plaza Pavers
  - 1. Finish: Granite-Tech™  
Stamp-Tech™  
Cool-Roof™
  - 2. Size: 12" x 12" x 1"  
12" x 12" x 2"  
12" x 24" x 1-1/2"  
16" x 16" x 1-1/2"  
16" x 24" x 1-1/2"  
20" x 20" x 2"
  - 3. Color: Standard or Custom Colors range.

#### SELECT ONE SYSTEM BELLOW OR COMBINE

- B. Uni-Just Pedestal System
  - 1. Uni-Base
  - 2. Uni-Cap
  - 3. Uni-Collar
  - 4. Uni-Insert: Model 3/4" or 1-1/2"
  - 5. Uni-Shim: Model 1/16" and 1/8"
  - 6. Uni-Spacer
  - 7. Uni-Buffer Pad
  - 8. SDR-35 PVC Pipe (4.215" OD)  
User supplied and cut to desired height.
- C. Stack-Cap Pedestal System
  - 1. Stack-Cap
  - 2. Uni-Shim: Model 1/16" and 1/8"
  - 3. Uni-Spacer
  - 4. Uni-Buffer Pad
  - 5. SDR-35 PVC Pipe (4.215" OD)

### PART THREE - EXECUTION

#### 3.1 EXAMINATION

- A. Examine area to receive Roof Pavers and Pedestal system and verify:
- B. Substrate surface are smooth, sound, clean and free of irregularities.
- C. Related work penetrating the plane of roof is completed.
- D. Verify that the roof deck will sustain the weight of the Paver System.
- E. Do not commence paver application until unsatisfactory conditions are satisfied.

#### 3.2 PREPARATION

- A. Broom deck surface clean.

#### 3.3 INSTALLATION

- A. Install in accordance with Tile Tech Pavers and other contributing manufacturer's instructions.
- B. First, determine a starting point; this will be largely dependent on where less than full size pavers are to be used.
- C. Establish a grid pattern for the pedestals using chalk lines.
- D. Use a laser leveling device or a mason's line to determine finished elevation of the deck surface and height of PVC Pipe to be cut. Assemble Adjustable Pedestal System components and place at grid line intersections.
- E. Install Tile Tech Roof Pavers on top of pedestals. Fine tune adjustments to the paver surface can be made by using the pedestal shims.
- F. Clean and remove any cut dust, resulting from WET or DRY cutting technique, that may have settled on surface of pavers installed or stored near the cutting area. Cut dust will discolor paver surface once it gets wet and dries and will require cleaning with an acid based cleaner.

*For complete material & installation specifications, please contact Tile Tech Pavers*



 888-380-5575

 213-380-5561

 Sales@tiletechpavers.com

 www.TileTechPavers.com